

Article number: 6100110041071

Description: 06B1

Extended pin one side only, connecting link

Measures

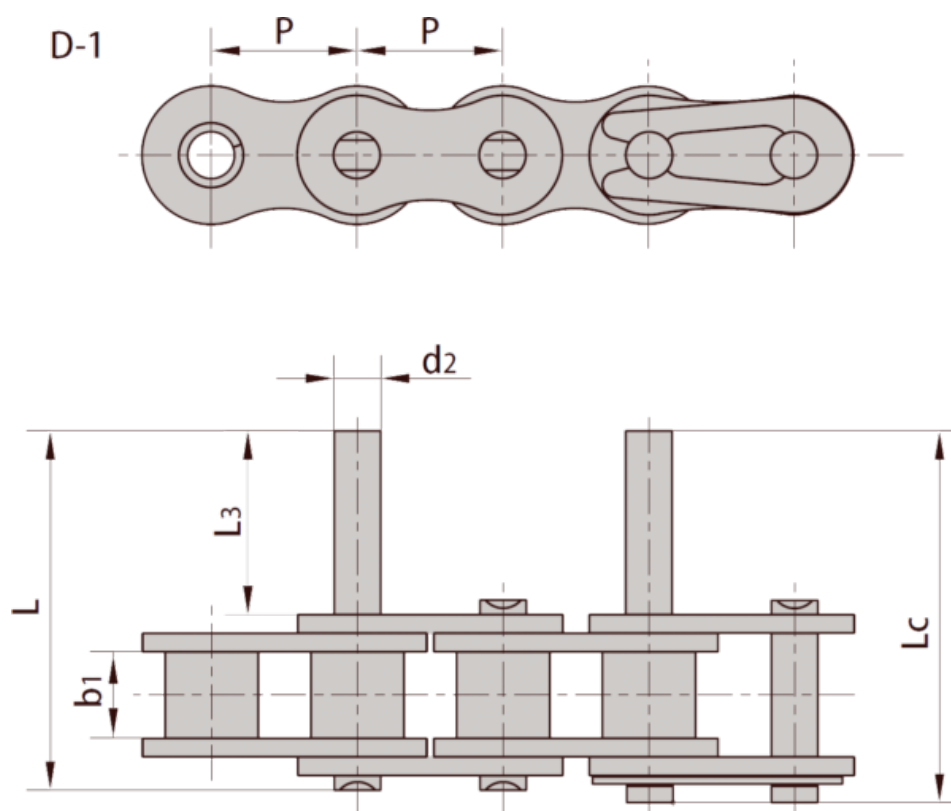

$b1 = 4.77$

$d2 = 3.58$

$L = 20.8$

$L3 = 9.5$

$Lc = 21.6$

$P = 9525$